

APAYKAYIŞ

ENDÜSTRİYEL GÜÇ AKTARMA

**MODÜLER BANT
ÜRÜN
KATALOĞU**

Kullanım Alanları

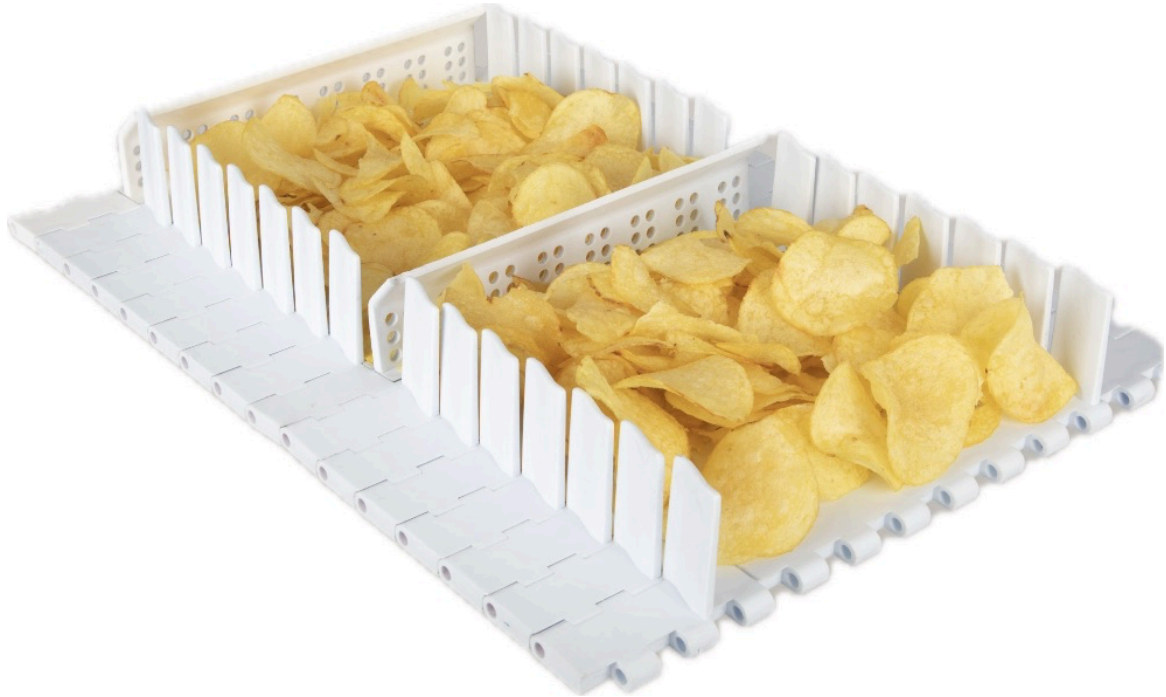

12.7

MODELLER

- Düz
- Süzgeçli

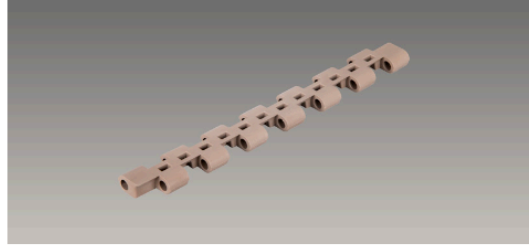
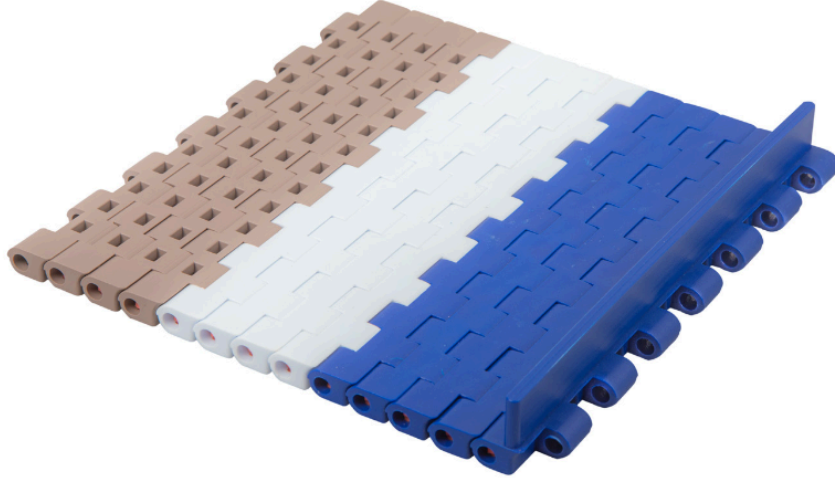

12.7 ÖLÇÜLERİ

mm	mm	mm	mm	mm	mm	mm
51	307	563	820	1077	1332	1587
76	333	58	846	1102	1357	
102	358	615	872	1128	1383	
127	383	640	897	1153	1408	
153	409	666	923	1179	1434	1949
178	435	692	948	1204	1459	1976
204	460	717	974	1230	1485	
230	486	743	1000	1255	1510	2001
255	512	769	1026	1281	1536	2975
281	537	794	1051	1306	1561	3000



12.7 DİŞLİ ÖLÇÜLERİ

DİŞLİ SAYISI	DİŞLİ ÇAPI	GÖBEK	GÖBEK	GÖBEK
Z18	75	Ø 25		
Z29	115	Ø 25		
Z33	135	Ø 25		
Z36	150		Ø 40	

25.4

MODELLER

- Düz
- Süzgeçli
- Mazgallı
- Kaburgalı
- Yeni Süzgeçli
- Yan Kulaklı

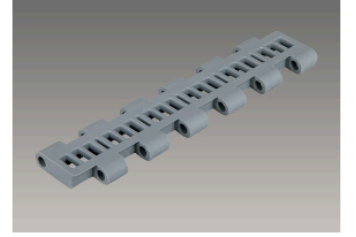
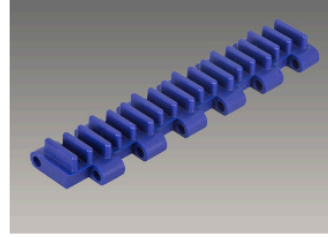
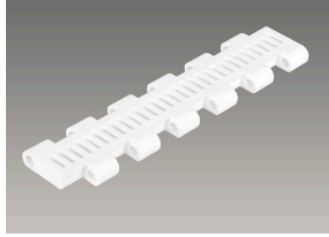
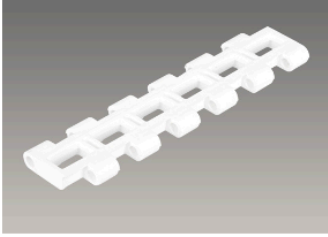
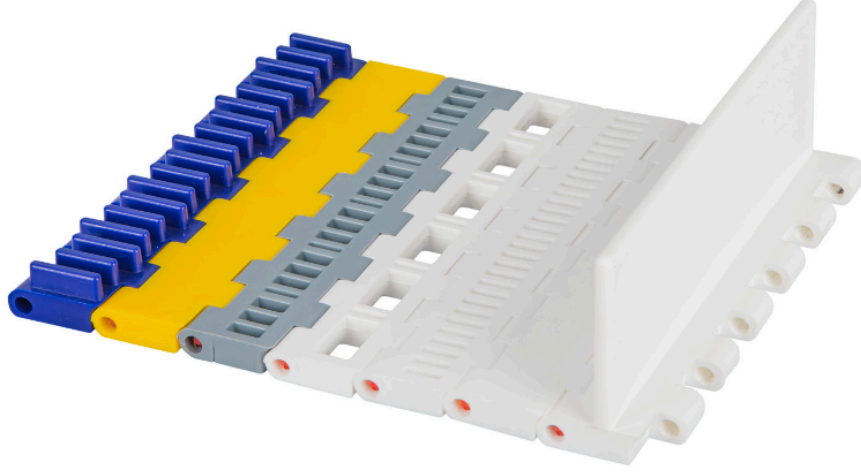

25.4 ÖLÇÜLERİ

mm	mm	mm	mm	mm	mm	mm
51	307	563	820	1077	1332	1587
76	333	58	846	1102	1357	
102	358	615	872	1128	1383	
127	383	640	897	1153	1408	
153	409	666	923	1179	1434	1949
178	435	692	948	1204	1459	1976
204	460	717	974	1230	1485	
230	486	743	1000	1255	1510	2001
255	512	769	1026	1281	1536	2975
281	537	794	1051	1306	1561	3000



25.4 DIŞLİ ÖLÇÜLERİ

DIŞLİ SAYISI	DIŞLİ ÇAPI	GÖBEK	GÖBEK	GÖBEK
Z6	47	Ø 25		
Z8	68	Ø 25		
Z10	81	Ø 25	Ø 40	
Z12	98	Ø 25	Ø 40	
Z15	123	Ø 25	Ø 40	
Z18	146	Ø 25	Ø 40	
Z20	160	Ø 25	Ø 40	
Z22	180		Ø 40	

■ 38.1

MODELLER

- Bakla Bant
- Dönüslü Bant
- Yarasa Bant

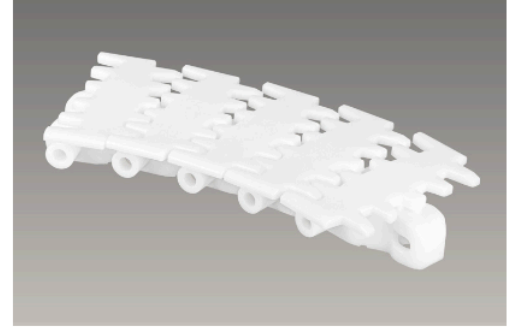
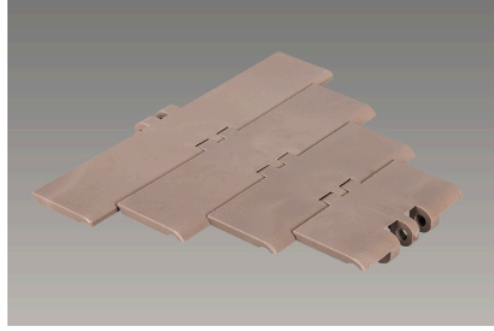

38.1 BAKLA BANT	38.1 YARASA BANT
mm	mm
40	82
82	150
101	250
114	
153	
190	
300	



38.1 BAKLA BANT DIŞLİ ÖLÇÜSÜ

DIŞLİ SAYISI	DIŞLİ ÇAPI	GÖBEK	GÖBEK	GÖBEK
Z19	155	Ø 25		
Z21	130	Ø 25		
Z25	155	Ø 25		

38.1 DÖNÜŞLÜ BANT DIŞLİ ÖLÇÜSÜ

DIŞLİ SAYISI	DIŞLİ SAYISI	GÖBEK	GÖBEK	GÖBEK
Z10	120	Ø 25		
Z12	140	Ø 25		

38.1 YARASA BANT DIŞLİ ÖLÇÜSÜ

DIŞLİ SAYISI	DIŞLİ SAYISI	GÖBEK	GÖBEK	GÖBEK
Z8	95	Ø 25		

APAYKAYIŞ

ENDÜSTRİYEL GÜÇ AKTARMA

50.8

MODELLER

- Düz
- Süzgeçli
- Mazgallı
- Kaburgalı
- Noktalı
- Temizlenebilir

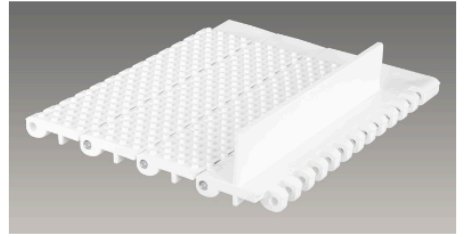
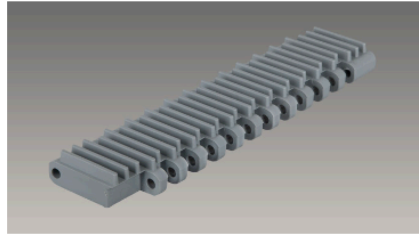
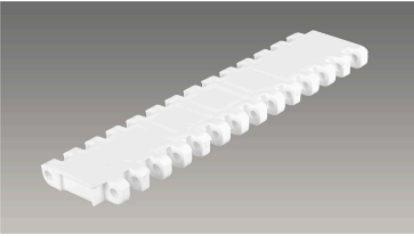
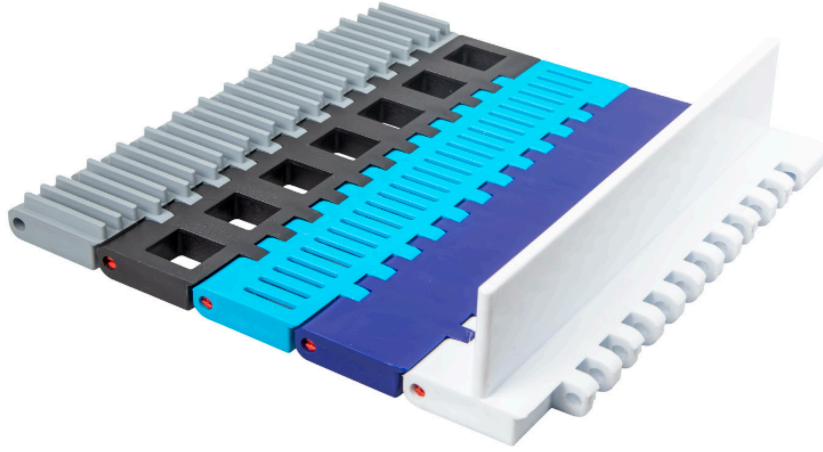

50.8 ÖLÇÜLERİ

mm	mm	mm	mm	mm	mm	mm
187	562	940	1320	1697	2074	2452
225	600	977	1357	1735	2112	2490
262	638	1016	1395	1772	2151	2528
300	676	1054	1432	1810	2187	2565
337	713	1092	1470	1848	2226	2603
375	751	1130	1507	1886	2263	2641
412	790	1167	1545	1923	2300	2680
450	827	1205	1583	1961	2338	2716
487	865	1243	1622	1997	2377	2755
525	903	1281	1660	2036	2415	2792



50.8 DIŞLI ÖLÇÜLERİ

DIŞLI SAYISI	DIŞLI ÇAPI	GÖBEK	GÖBEK	GÖBEK
Z8	120		Ø 40	
Z10	160		Ø 40	
Z16	262			Ø 60

50.8 TEMİZLENEBİLİR DIŞLI ÖLÇÜLERİ

DIŞLI SAYISI	DIŞLI ÇAPI	GÖBEK	GÖBEK	GÖBEK
Z6	90	Ø 25		
Z8	160		Ø 40	
Z10	120		Ø 40	

■ **ASESUARLAR**



■ **KONSOL TAKIMI**

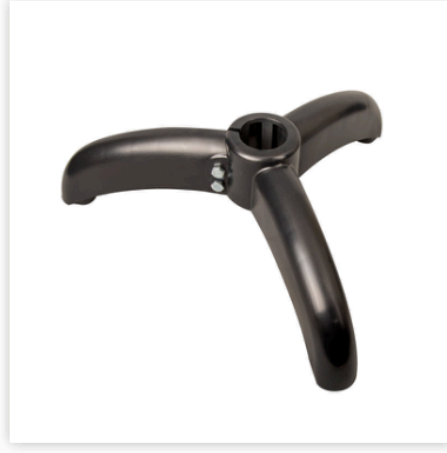

■ **3'LÜ AYAK**



■ **2'Lİ AYAK**



■ **KELEPÇE**



■ **YAN BAĞLANTI**



■ **KARE BAĞLANTI**



■ **PAPUÇ**



■ **TEKLİ MİL TUTUCU**

ZİNCİR KIZAKLARI

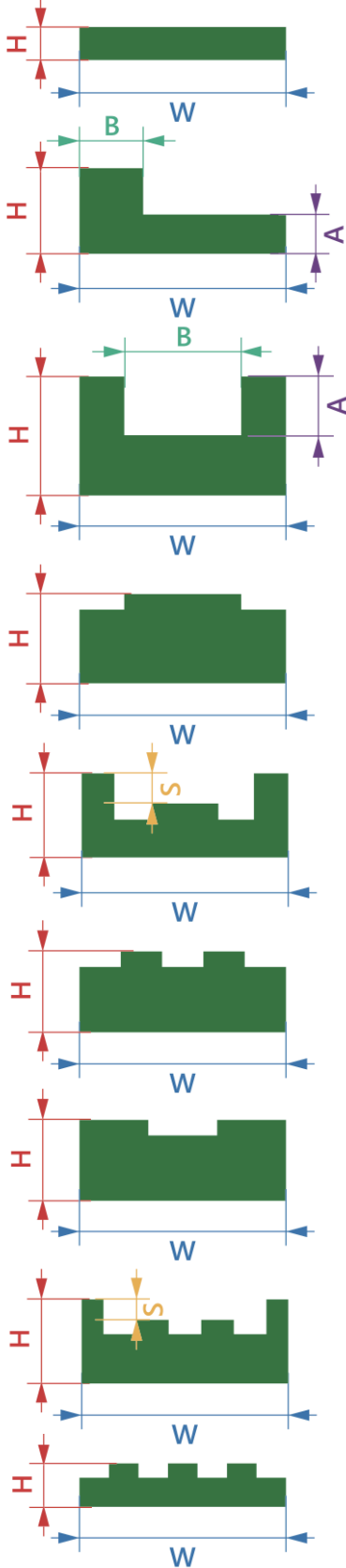

LAMA MODEL PE 1000 PROFİL		
W	H	KRM LY1 520-KRM LY1 525
		KRM LY1 530-KRM LY1 540

L MODEL 1000 PROFİL				
W	H	A	B	KRM LE1 000

U MODEL PE 1000 PROFİL				
W	H	A	B	KRM UY1 000

T MODEL PE 1000 ZİNCİR KIZAĞI			
HATVE	W	H	
3/8"	15	10	KRM T01 038
1/2"	20	10-15	KRM T01 012
5/8"	20	10-15	KRM T01 058
3/4"	25	10-15	KRM T01 034
1"	40	15-20	KRM T01 001

KANALLI T MODEL PE 1000 ZİNCİR KIZAĞI				
HATVE	W	H	S	
3/8"	25	10	4,4	KRM KT1 038
1/2"	30	15	7,2	KRM KT1 012
5/8"	33	20	9,5	KRM KT1 058
3/4"	38	20	11,1	KRM KT1 034
1"	51	25	16,5	KRM KT1 001

2 SIRA T MODEL PE 1000 ZİNCİR KIZAĞI			
HATVE	W	H	
3/8"	25	10	KRM T02 038
1/2"	35	10	KRM T02 012
5/8"	40	15	KRM T02 058
3/4"	45	15	KRM T02 034
1"	75	15	KRM T02 001

2T MODEL PE 1000 ZİNCİR KIZAĞI					
3/8"	1/2"	5/8"	3/4"	1"	
W: 20 H: 10	W: 28 H: 10	W: 28 H: 15	W: 31 H: 15	W: 48 H: 15	

2 SIRALI KANALLI T MODEL PE 1000 ZİNCİR KIZAĞI				
HATVE	W	H	S	
3/8"	36	15	4,4	KRM KT2 038
1/2"	45	20	7,2	KRM KT2 012
5/8"	50	25	9,5	KRM KT2 058
3/4"	56	25	11,1	KRM KT2 034
1"	85	30	16,5	KRM KT2 001

2 SIRA T MODEL PE 1000 ZİNCİR KIZAĞI			
HATVE	W	H	
3/8"	35	10	KRM T03 038
1/2"	45	15	KRM T03 012
5/8"	55	10	KRM T03 058
3/4"	65	10	KRM T03 034
1"	95	15	KRM T03 001

ZİNCİR KIZAKLARI

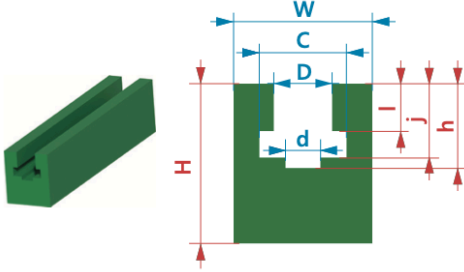

DİK ZİNCİR ÇALIŞMASINA UYGUN SACSIZ ZİNCİR KIZAĞI										
Malzeme	Hatve	w(mm)	H(mm)	C(mm)	h(mm)	l(mm)	J(mm)	d(mm)	D(mm)	PASLANMAZ SAÇLI KOD
PE 1000	3/8"	20,0	25,0	9,3	10	5,6	8,7	4,0	6,6	KRM D10 038
	1/2"	24,0	30,0	12,8	12,7	7,6	11,5	5,0	8,7	KRM D10 012
	5/8"	30,0	35,0	15,4	14,8	9,5	13,5	6,0	10,4	KRM D10 058
	3/4"	40,0	35,0	16,9	17,5	11,5	15,9	7,0	12,3	KRM D10 034
	1"	40,0	45,0	24,4	28,2	15,9	25,7	9,0	16,2	KRM D10 001

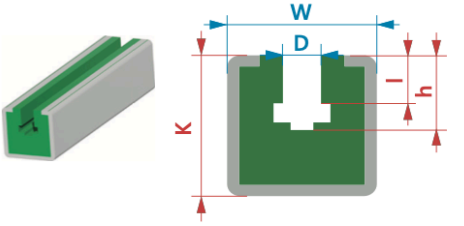

DİK ZİNCİR ÇALIŞMASINA UYGUN SAÇLI ZİNCİR KIZAĞI										
Malzeme	ÇELİK PROFİL MALZEMESİ	Hatve	W	K	H	I	D	GALVANİZ SAÇLI KOD	PASLANMAZ SAÇLI KOD	
PE 1000	GALVANİZ PASLANMAZ	3/8"	30	24	10,0	5,6	6,6	KRM D1Z 038	KRM D1S 038	
	GALVANİZ PASLANMAZ	1/2"	30	24	12,7	7,6	8,7	KRM D1Z 012	KRM D1S 012	
	GALVANİZ PASLANMAZ	5/8"	30	24	14,8	9,5	10,4	KRM D1Z 058	KRM D1S 058	
	GALVANİZ PASLANMAZ	3/4"	30	24	17,5	11,5	12,3	KRM D1Z 034	KRM D1S 034	
	GALVANİZ PASLANMAZ	1"	45	40	28,2	15,9	16,2	KRM D1Z 001	KRM D1S 001	

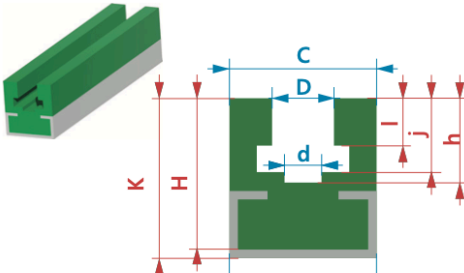

DİK ZİNCİR ÇALIŞMASINA UYGUN SAÇLI ZİNCİR KIZAĞI										
Malzeme	ÇELİK PROFİL MALZEMESİ	Hatve	W	H	K	I	J	h	C	
PE 1000	GALVANİZ PASLANMAZ	3/8"	20	17,5	21	5,6	8,7	10,0	20,0	
	GALVANİZ PASLANMAZ	1/2"	28	27,5	32	7,6	11,5	12,7	28,0	
	GALVANİZ PASLANMAZ	5/8"	28	27,5	32	9,5	13,5	14,8	28,0	
	GALVANİZ PASLANMAZ	3/4"	38	34	43	11,5	15,9	17,5	38,0	
	GALVANİZ PASLANMAZ	1"	38	40	50	15,9	25,7	28,2	38,0	

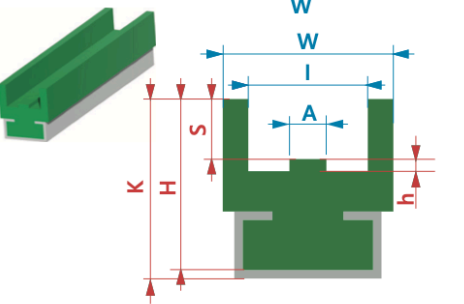

KANALLI T MODEL YATAY ZİNCİR ÇALIŞMASINA UYGUN SAÇLI ZİNCİR KIZAĞI											
Malzeme	ÇELİK PROFİL MALZEMESİ	Hatve	W	H	K	I	h	A	S	GALVANİZ SAÇLI KOD	PASLANMAZ SAÇLI KOD
PE 1000	GALVANİZ PASLANMAZ	3/8"	25	15	18,0	15,0	1,5	5,4	4,4	KRM KT1Z 038	KRM KT1S 038
	GALVANİZ PASLANMAZ	1/2"	30	25	27,0	20,0	2,2	7,4	7,2	KRM KT1Z 012	KRM KT1S 012
	GALVANİZ PASLANMAZ	5/8"	33	30	32,0	23,0	2,6	9,2	9,5	KRM KT1Z 058	KRM KT1S 058
	GALVANİZ PASLANMAZ	3/4"	38	35	40,0	28,0	2,4	11,3	11,1	KRM KT1Z 034	KRM KT1S 034
	GALVANİZ PASLANMAZ	1"	51	40	45,0	41,0	3,5	16,5	16,5	KRM KT1Z 001	KRM KT1S 001

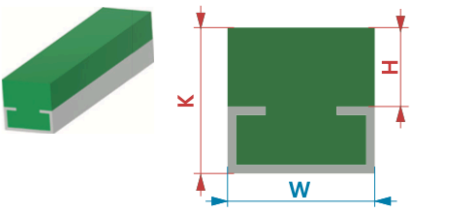

KRM-DÜZ DÜZ SAÇLI DAYAMA PROFİLİ						
Malzeme	ÇELİK PROFİL MALZEMESİ	W	K	H	GALVANİZ SAÇLI KOD	PASLANMAZ SAÇLI KOD
PE 1000	GALVANİZ PASLANMAZ				KRM DPZ 000	KRM DPS 000
	KULLANICININ İSTEĞİNE GÖRE YAPILIR					

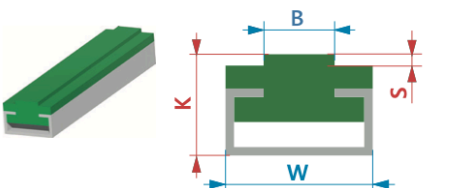

KRM-T1-Z/S SAÇLI YATAY T MODEL ZİNCİR KIZAĞI								
Malzeme	ÇELİK PROFİL MALZEMESİ	Hatve	W	K	B	S	GALVANİZ SAÇLI KOD	PASLANMAZ SAÇLI KOD
PE 1000	GALVANİZ PASLANMAZ	3/8"	20	18,0	5,4	1,5	KRM T1Z 038	KRM T1S 038
	GALVANİZ PASLANMAZ	1/2"	20	18,0	7,4	2,2	KRM T1Z 012	KRM T1S 012
	GALVANİZ PASLANMAZ	5/8"	28	18,0	9,2	2,6	KRM T1Z 058	KRM T1S 058
	GALVANİZ PASLANMAZ	3/4"	28	18,0	11,3	2,4	KRM T1Z 034	KRM T1S 034
	GALVANİZ PASLANMAZ	1"	28	25,0	16,5	3,5	KRM T1Z 001	KRM T1S 001

■ ZİNCİR KIZAKLARI

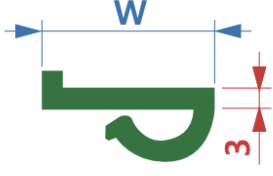

KRM-TZ TIRNAKLI (KIRLANGIÇ) Z PROFİL	
W	KOD
20	KRM TZ0 320
25	KRM TZ0 325

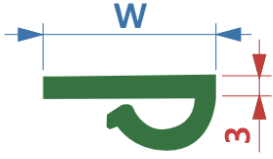

KRM-TZ TIRNAKLI (KIRLANGIÇ) LAMA PROFİL	
W	KOD
20	KRM TLO 320
25	KRM TLO 325

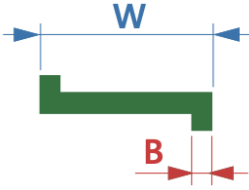

KRM-"Z" PROFİL		
W	B	KOD
20	3	KRM Z00 320
23	4	KRM Z00 423

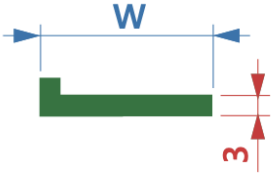

KRM-"L" PROFİL	
W	KOD
20	KRM L00 320

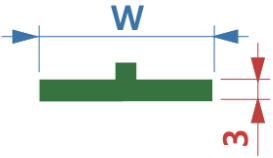

KRM-"T" PROFİL	
W	KOD
40	KRM 00T 340

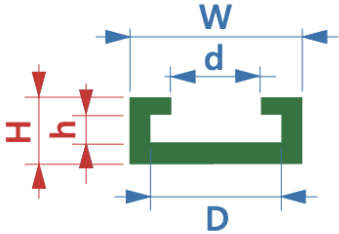

"C" KAYIT KENAR PROFİLİ			
W	H	AL GEÇMELİ	KRM-CG
30		KRM CG0 030	KRM C00 030
40		KRM CG0 040	KRM C00 040
50		KRM CG0 050	KRM C00 050
60		KRM CG0 060	KRM C00 060

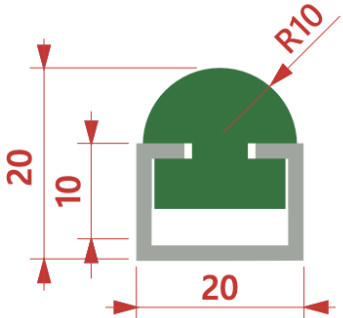

KRM-"MD" D KAYIT KENAR MANTAR PROFİL	
KRM MDO 001	SAÇSIZ
KRM MDZ 002	GALVANİZ SAÇLI
KRM MDS 003	PASLANMAZ SAÇLI



Daha fazlası için QR kodu okutun